

---

## **INSTRUCTIONS FOR USE**

Induction hob

EN

HID144/654/754/865MC

HID925/945/956MC

HID352/654/754GC

HID824/956/965GC

HID144/754/865MFC

HID925/956MFC

# Contents

<b>Safety</b> .....	<b>3</b>	Cooking with Celsius°Cooking™ .....	25
<b>Introduction</b> .....	<b>7</b>	Cooking with Celsius°Cooking™ cookware and Hestan Cue programs .....	26
Dear customer! .....	7	Step-by-Step cooking guide on CelsiusCooking.com .....	30
<b>Your hob</b> .....	<b>9</b>	Hood control .....	31
Induction hob .....	9	<b>ConnectLife and Wi-Fi</b> .....	<b>32</b>
<b>Use</b> .....	<b>10</b>	<b>ConnectLife</b> -app and Wi-Fi connection .....	32
Using the touch controls .....	10	<b>Firmware Update</b> .....	<b>35</b>
Induction cooking .....	10	<b>Settings</b> .....	<b>36</b>
How does induction work .....	11	<b>Maintenance</b> .....	<b>39</b>
Power management .....	11	Cleaning .....	39
Pans .....	12	<b>Troubleshooting</b> .....	<b>40</b>
Induction noises .....	13	General .....	40
Power level settings .....	14	Troubleshooting Wi-Fi .....	42
<b>Control panel</b> .....	<b>15</b>	<b>Installation</b> .....	<b>43</b>
<b>Indications on the display</b> .....	<b>16</b>	<b>Safety</b> .....	43
<b>Operation</b> .....	<b>17</b>	<b>Installing a built-in hob</b> .....	45
Switching the hob on/off .....	17	Air vents in the lower kitchen cabinet .....	47
Child lock .....	17	Flush-mount installation into the worktop .....	48
Cooking .....	18	Fitting the foam gasket .....	51
Standard cooking .....	18	<b>Electrical installation</b> .....	<b>52</b>
Move function .....	19	Connecting the cooking hob to the power mains .....	52
Automatic cooking zone bridging .....	19	Connection .....	52
Chef mode .....	19	Current limiter .....	59
Pause .....	20	<b>Environmental aspects</b> .....	<b>60</b>
Recall function .....	20	Disposal of packaging and appliance .....	60
Time functions .....	21	<b>Compliance information</b> .....	<b>61</b>
Hot cooking zone .....	22		
Overheat protection .....	22		
Cooking with the PLUS menu .....	23		

**⚠ WARNING!**

Before use, read the Safety instructions first!

**General safety instruction**

The appliance is not intended to be operated by means of an external timer or separate remote-control system.

If the supply cord is damaged, it must be replaced by the manufacturer, its service agent or similarly qualified persons in order to avoid a hazard (only for appliances supplied with connection cord).

Do not use steam cleaners or high-pressure cleaners to clean the appliance, as this may result in an electric shock.

**CAUTION!**

CAUTION: The cooking process has to be supervised. A short term cooking process has to be supervised continuously.

Metallic objects such as knives, forks, spoons and lids should not be placed on the hob surface since they can get hot.

After use, switch off the hob element by its control and do not rely solely on the pan detector.

**Danger of fire!**

Danger of fire: Do not store items on the cooking surfaces.

**Households with children and people with special needs**

This appliance can be used by children aged from 8 years and above and persons with reduced physical, sensory or mental capabilities or lack of experience and knowledge if they have been given supervision or instruction concerning use of the appliance in a safe way and understand the hazards involved. Children shall not play with the appliance. Cleaning and user maintenance shall not be made by children without supervision.

# Safety

Children should be supervised to ensure that they do not play with the appliance.

## WARNING!

WARNING: The appliance and its accessible parts become hot during use. Care should be taken to avoid touching heating elements. Children younger than 8 years of age shall be kept away unless continuously supervised.

WARNING: Accessible parts may become hot during use. Young children should be kept away.

WARNING: Accessible parts will become hot when in use. To avoid burns and scalds children should be kept away.

## **Risk of electric shock!**

## WARNING!

WARNING: If the surface is cracked, switch off the appliance to avoid the possibility of electric shock.

WARNING: Unattended cooking on a hob with fat or oil can be dangerous and may result in fire. NEVER try to extinguish a fire with water, but switch off the appliance and then cover flame e.g. with a lid or a fire blanket.

WARNING: Danger of fire: do not store items on the cooking surfaces.

Means for disconnection must be incorporated in the fixed wiring in accordance with the wiring rules.

The appliance is intended for household use. Do not use it for any other purpose, such as room heating, drying of pets or other animals, paper, fabrics, herbs etc. As this may lead to injury or fire hazard.

The appliance may only be connected to the power mains by an authorised service technician or expert. Tampering with the appliance or non-professional repair thereof may result in risk of severe injury or damage to the product.

If another electrical appliance is connected to an AC power socket near the appliance, make sure the power cord does not come into contact with hot cooking zones.

If the power cord is damaged, it should be replaced by the manufacturer or an authorised service technician, in order to avoid hazard.

Using the glass ceramic hob as a storage area may result in scratches or other damage to it. Never heat food in aluminium foil or in plastic containers on the cooking hob. Such foil or containers may melt which can result in a fire or damage to the cooking hob.

Do not store temperature-sensitive items underneath the appliance, such as cleaners or detergents, spray cans etc.

## WARNING!

Carefully read the instructions for use before connecting the appliance. Repair or any warranty claim resulting from incorrect connection or use of the appliance shall not be covered by the warranty.

## **Temperature safety**

A sensor continuously measures the temperature of certain parts of the hob. Every cooking zone is equipped with a sensor that measures the temperature of the glass-ceramic cooking zone to avoid any risk of overheating when a pan boils dry. In case of temperatures rising too high, the power is reduced automatically, or the hob switches off automatically.

## **Cooking-time limiter**

The cooking-time limiter is a safety function of your cooking appliance. It will operate if you forget to switch off your hob.

Depending on the setting you have chosen, the cooking time will be limited as follows:

# Safety

<b>Setting</b>	<b>The cooking zone switches off automatically after:</b>
1 and 2	9 hours
3, 4 and 5	6 hours
6, 7 and 8	4 hours
9	3 hours
10	2 hours
11 and 12	1 hour

The cooking-time limiter switches the cooking zones off if the time in the table has elapsed.

<b>Setting</b>	<b>The cooking zone switches automatically to setting 12 after:</b>
boost	10 minutes

Cooking-time limiter for specific cooking zone is reset after the user has changed the cooking level of the specific cooking zone.

## NOTE!

Cooking zone related timers take priority over the cooking-time limiter.

## Dear customer!

Welcome to our growing Celsius Cooking family!

We are proud of our appliances. We hope that this appliance will be an appreciated and dependable aid for many years to come.

Please read the operating instructions before use. They include general tips, information about the settings and adjustments you can make, and the best way to take care of your appliance.

This hob has been designed for the real lover of cooking. Cooking on an induction hob has a number of advantages. It is easy, because the hob reacts quickly and can also be set to a very low power level. Because, moreover, it can also be set to a high power level, it can bring dishes to the boil very quickly. The ample space between the cooking zones makes cooking comfortable.

Cooking on an induction hob is different from cooking on a traditional appliance. Induction cooking makes use of a magnetic field to generate heat. This means that you cannot use just any pan on it. The pans section gives more information about this.

For optimum safety the induction hob is equipped with several temperature protections and a residual heat indicator, which shows which cooking zones are still hot.

This manual describes how you can make the best possible use of the induction hob. In addition to information about operation, you will also find background information that can assist you in using this product. You will also find cooking tables and maintenance tips.

**Read the manual thoroughly before using the appliance, and store these instructions in a safe place for future reference.**

The manual also serves as reference material for service technicians. **Please, therefore, stick the appliance identification card at the back of the manual.** The appliance identification card contains all the information that the service technician will need in order to respond appropriately to your needs and questions.

Enjoy your cooking!

# Introduction

The following symbols are used throughout the manual and they have the following meanings:

 **INFORMATION!**

Information, advice, tip, or recommendation

 **WARNING!**

Warning – general danger

 **ELECTRIC SHOCK!**

Warning – danger of electric shock

 **HOT SURFACE!**

Warning – danger of hot surface

 **DANGER OF FIRE!**

Warning – danger of fire



## Induction hob

(depending on the model)

Since the appliances for which these instructions were drawn up may have different features, some functions or equipment may be described in the manual that may not be present in your appliance.

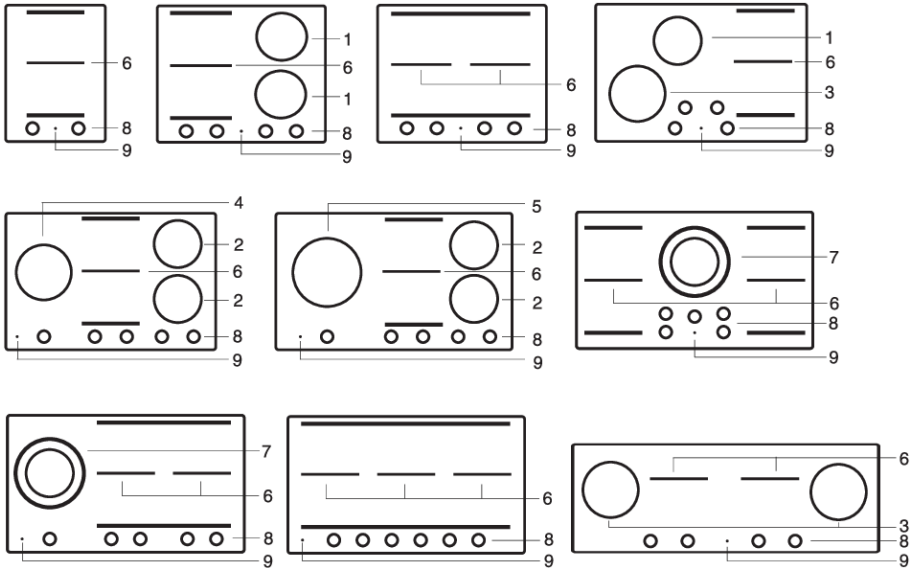

1. Cooking zone  $\varnothing$  18 cm - Max. 1.85 kW / 3.0 kW (boost)
2. Cooking zone  $\varnothing$  18 cm - Max. 1.4 kW / 3.0 kW (boost)
3. Cooking zone  $\varnothing$  21 cm - Max. 2.3 kW / 3.7 kW (boost)
4. Cooking zone  $\varnothing$  21 cm - Max. 2.3 kW / 3.0 kW (boost)
5. Cooking zone  $\varnothing$  26 cm - Max. 2.6 kW / 3.7 kW (boost)
6. Bridge induction cooking zone 18 x 22 cm - Max. 2.3 kW / 3.7 kW (boost)
7. Cooking zone Double Ring:  
 $\varnothing$  18 cm - Max. 1.85 - 3.0 kW (boost)  
 $\varnothing$  26 cm - Max. 2.60 - 5.5 kW (boost)
8. Control panel (visible only when the hob is turned on)
9. On/Off touch key

### INFORMATION!

The maximum power output is depending on the type of cookware used and the thermal condition of the appliance.

## Using the touch controls

- The touch controls may take some getting used to if you are used to other (rotary) controls. Place the tip of your finger flat on the control to achieve the best results. You do not have to apply any pressure.
- The touch sensors only react to the light pressure of a fingertip. Do not operate the controls with any other objects.
- The cooking hob is operated by a slider. You can either touch the selected part of the slider or slide in a circular motion clockwise to increase or anti-clockwise to decrease the power level and temperature.
- To set the cooking zone power level, touch the desired spot on the slider. As you touch the slider, the selected power level will appear on the cooking zone display unit.
- The selected part of the slider will be fully lit.

## Induction cooking

### Induction cooking is fast

In the beginning you will be surprised by the speed of induction cooking. Especially at higher settings, foods and liquids will boil very rapidly.

It is best not to leave pans unattended to avoid them boiling over or boiling dry.



Always keep the lid on the pan when cooking, in order to avoid energy loss, and therefore temperature loss.

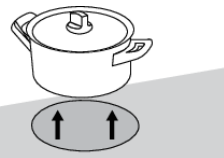

### Attention

Only put pans with a clean base on the cooking surface and always pick pans up to move them.

Grains of sand, salt, sugar or crystals may cause scratches which cannot be removed.



## How does induction work

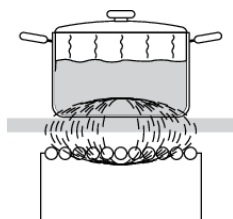

A magnetic field is generated in the appliance. By placing a pan with an iron base on a cooking zone, a current is induced in the pan base. This induced current generates heat in the base of the pan.

### Easy

The electronic controls are accurate and easy to set. On the lowest setting, you can melt chocolate directly in the pan, for example, or cook ingredients that you would normally heat in a bain-marie.

### Fast

Thanks to the induction hob's high power levels, bringing liquid to the boil is very quick. Cooking food through takes just as long as for other types of cooking.

### Clean

The hob is easy to clean. Because the cooking zones do not get any hotter than the pans themselves, food spills cannot be burnt on the cooking zone.

### Safe

The heat is generated in the pan itself. The glass top does not get any warmer than the pan. This means that the cooking zone is considerably cooler compared to that from a ceramic hob or a gasburner. Once a pan has been taken away, the cooking zone cools down quickly.

## Power management

This induction hob is equipped with a smart power management system. This system ensures a maximum permissible power cannot be exceeded for safety reasons.

- The smart power management system will arrange the power distribution across the zones automatically. This means the hob could automatically decrease the power on one zone when the power level of another zone is increased. The level of activity of the power management system depends on the available power per electrical phase, the setting of the current limiter and the connected load.
- The power level of one zone can affect the power of another zone as the maximum available power is distributed among the zones. If the combined zones reach the maximum available power when a new power level is set, the power levels of one or more zones are automatically reduced within the power limit. This is indicated by the flashing of the relevant control element.
- In case a zone is used for Celsius Cooking, this zone always gets highest priority.
- Intervention by the smart power management system is more likely when the current limiter is set to a lower level.
- The current limiter setting must be set according to your connection and circuit breakers by a registered and qualified installer (see 'Current limiter' for the details on currents and electrical installation).

# Use

## Pans

### Pans for induction cooking

Induction cooking requires a particular quality of pan.

#### WARNING!

Pans that have already been used for cooking on a gas hob are no longer suitable for use on an induction hob.

Only use pans that are suitable for induction cooking with a thick base (minimum 2.25 mm) and a flat base.

- The best are pans with the 'Class Induction' quality mark.

#### INFORMATION!

You can check for yourself whether your pans are suitable using a magnet. A pan is suitable if the base of the pan is sufficiently attracted by the magnet.

Suitable	Unsuitable
Special stainless steel pans	Earthenware
Class Induction	Stainless steel
Hard-wearing enamelled pans	Porcelain
Enamelled cast-iron pans	Copper
	Plastic
	Aluminium

#### WARNING!

Be careful with enamelled sheet-steel pans:

- the enamel may chip (the enamel comes loose from the steel), if you switch the hob on at a high setting when the pan is (too) dry
- the base of the pan may warp - for example: Due to overheating
- heat up enamelled pans slowly



### WARNING!

Never use pans with a misshapen base. A hollow or rounded base can interfere with the operation of the overheating protection, so that the appliance becomes too hot. This may lead to the glass top cracking and the pan base melting. Damage arising from the use of unsuitable pans or from boiling dry is excluded from the guarantee.

### Minimum pan diameter

The diameter of the bottom of the pan must be at least 12 cm. You will achieve the best results by using a pan with the same diameter as the cooking zone. If a pan is too small the zone will not work.

### Pressure cookers

Induction cooking is very suitable for cooking in pressure cookers. The cooking zone reacts very quickly, and so the pressure cooker is quickly up to pressure. As soon as you switch a cooking zone off, the heating process stops immediately.

### Pan detection

The cooking zone automatically detects a suitable pan placed on a cooking zone. The cooking zone display lights up.

### Integrated pan recognition

If a certain power level is set for a cooking zone and there is no suitable pan or any pan on the cooking zone, then the cooking zone will not deliver any power. After a certain period, the cooking zone will switch off automatically.

### Grill plates

The hob has a Grill function (depending on the model) for using a grill plate or teppan yaki. The function keeps the grill plate or teppan yaki at an ideal temperature for grilling.

## Induction noises

### A ticking sound

This sound can be caused at lower power level settings or by the automatic pot detection.

### Pans are making noise

Pans can make some noise during cooking. This is caused by the energy flowing from the hob to the pan. This is perfectly normal for some pans. It will not damage either the pans or the hob.

### The fan is making noise

To increase the lifespan and performance of the electronics, the appliance is equipped with fans. During intense use of the appliance, the fan is activated to cool down the appliance and you will hear a buzzing sound. The fan still runs for several minutes after the hob has been switched off.

## Power level settings

Because the settings depend on the quantity and composition of the contents of the pan, the table below is intended as a guideline only.

Level	Purpose
Use settings 1 - 5 to:	<ul style="list-style-type: none"><li>• simmer bouillon</li><li>• stew meats</li><li>• simmer vegetables</li><li>• melt chocolate</li><li>• poach</li><li>• melt cheese</li></ul>
Use settings 6 - 9 to:	<ul style="list-style-type: none"><li>• complete the cooking of large quantities</li><li>• defrost hard vegetables</li><li>• fry thick slices of breaded meat</li></ul>
Use settings 10 - 11 to:	<ul style="list-style-type: none"><li>• fry thick pancakes</li><li>• fry thick slices of breaded meat</li><li>• fry bacon (fat)</li><li>• cook raw potatoes</li><li>• make breaded fish</li><li>• cook through fish</li><li>• fry thin slices of breaded meat</li></ul>
Use setting 12 to:	<ul style="list-style-type: none"><li>• sear meats,</li><li>• cook fish,</li><li>• cook omelettes,</li><li>• fry boiled potatoes,</li><li>• deep fry foods.</li></ul>
Use setting 'boost' to:	<ul style="list-style-type: none"><li>• bring the food or liquid to the boil quickly</li><li>• shrink greens</li></ul>

### Power distribution of cooking zones





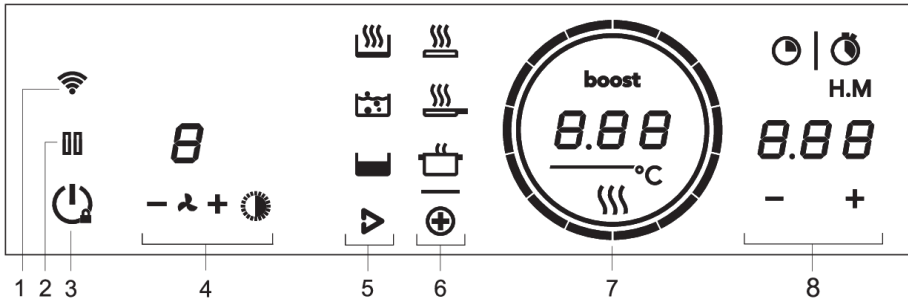

- Depending on the type of hob, the cooking zones can affect each other. When several of these cooking zones are switched on at the same time, the capacity is shared automatically between them.
- When the maximum capacity of the combination of cooking levels is reached during setting, one or more zones are automatically reduced to the highest possible setting at that moment. This is indicated by the flashing of the relevant control element.

(lay-out of user interface depends on model)



1. Wi-Fi/Connectivity
2. Pause
  - Key lock for cleaning
  - Pause and resume cooking
3. On/Off
  - Child lock
4. Hood control
  - Minus
  - Fan
  - Plus
  - Lighting
  - Display
5. Hestan Cue
  - Heating up and frying
  - Boiling/cooking with water
  - Slow cooking or sous vide
6. PLUS programs
  - Grill
  - Frying/wok
  - Heating up/keeping warm
7. Cooking Level or Temperature Display
  - Residual Heat indication
  - Boost indication
8. Time functions
  - Stopwatch
  - Kitchen timer

# Indications on the display

In display	Status
–	Power level '0' for a cooking zone
12	Power level that is set for a cooking zone; 1 = low / 12 = high
<b>boost</b>	Boost function active
L	Locking function is activated; the control panel is locked
≡	Residual heat indicator; The hob has a residual heat indicator for each cooking zone to show which cooking zones are hot after cooking zone is turned off. Although the hob is switched off, the indicator will remain on for as long as the cooking zone is hot! Avoid touching those cooking zones when this indicator is lit. <b>Danger! Risk of burns.</b>
E	Error code; See chapter Troubleshooting
⊕	<b>PLUS programs</b>
	Grill
	Frying/wok
	Heating up/keeping warm
▽	<b>Hestan Cue programs</b>
	Heating up and frying
	Boiling/cooking with water
	Slow cooking or sous vide



## Switching the hob on/off

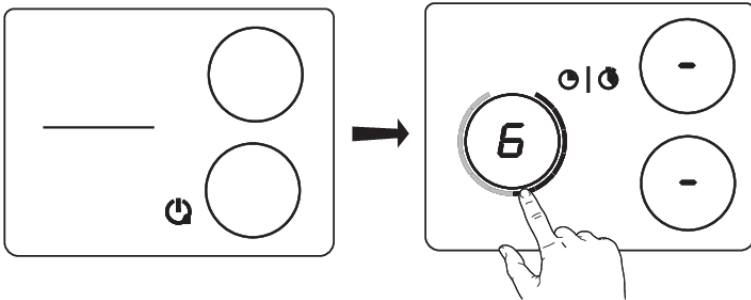

Touch the on/off key  to switch on the hob. A short beep will be emitted. Rings on all sliders will light up, then slider will gradually fade out. Slider will only remain lit on the selected cooking zones on which you have the pans placed. When the pan is removed, the slider will be switched off, while all internal rings will remain lit.



### INFORMATION!

When no cooking zone is active for 60 seconds, the cooking hob will power off.

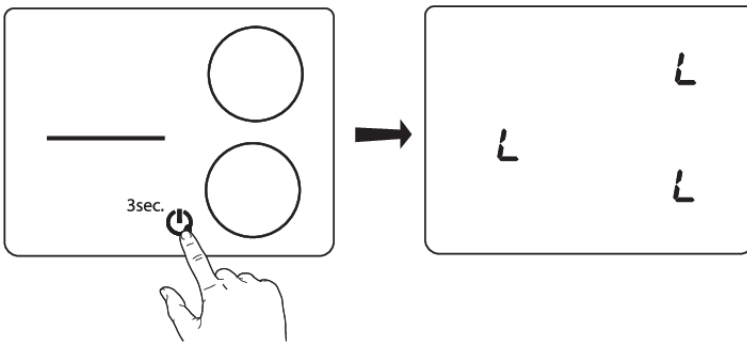
## Child lock



Cooking hob controls can be locked to prevent it from being switched on inadvertently.

Turn on the hob by pressing the on/off key. Touch the on/off key  and hold it for 3 seconds. The indication  will appear on the display unit, and the hob controls will be locked. To unlock the controls, proceed in the same way. The indication  together with sliders will appear on all cooking zone display on which pans are present, and the hob controls will be unlocked.

# Operation

## INFORMATION!

Child lock should be activated before the start of cleaning to avoid accidentally switching on the hob.

## Cooking

Three cooking modes are available:

1. Standard cooking with power levels
2. Cooking with the PLUS menu
3. Hestan Cue cooking by measuring cookware temperature

## Standard cooking

Place the pan on a certain cooking zone. Set the power level as desired. Power level can be set by sliding in circular motion or by directly touching an area or position on the slider. Slider elements will be fully lit. To switch the cooking zone off slide backwards or touch the empty area on top of the slider at the right side.

## Boost

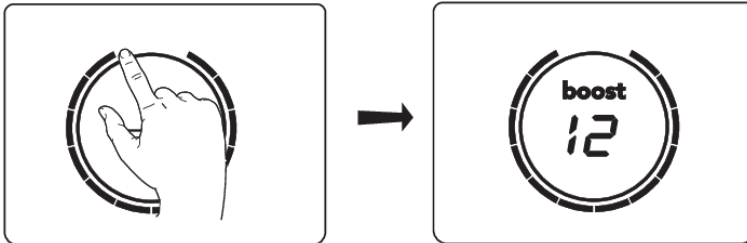

Rapid cooking, boost can be activated for any cooking zone. This will allow you to rapidly heat large amounts of food using extra power. Boost is active for no more than 10 minutes; then, the power level is automatically decreased to 12. If the cooking hob is not too hot, the boost can be reactivated again for 10 minutes after it is switched off.

## Activating boost

First activate power level 12 and then press the button for power level 12 a second time. **"boost"** will appear on the display. The boost function is now activated.

Alternatively, the power level 12 can be activated clockwise and slide a little beyond the button 12.

If auto boost is activated (see chapter Settings), boost is always activated together with power level 12.

## Deactivating boost

To deactivate the boost for the selected cooking zone, press level 12 again or any other power level on the slider.

## INFORMATION!

To avoid overheating, the electronic control system may automatically deactivate boost prematurely and decrease the power level to 12.

If there is no suitable pan on the cooking zone, the set level of temperature will flash. After one minute, the cooking zone will be switched off.

## Move function

If you remove the pan from an active cooking zone and within 6 seconds place it on a different cooking zone, all the timer and cooking-related settings can be transferred to the new cooking zone by touching the slider of the new cooking zone. To indicate this possibility, the new cooking zone displays copied settings on the slider. When the confirmation is done, the previous cooking zone is deactivated.

## Automatic cooking zone bridging

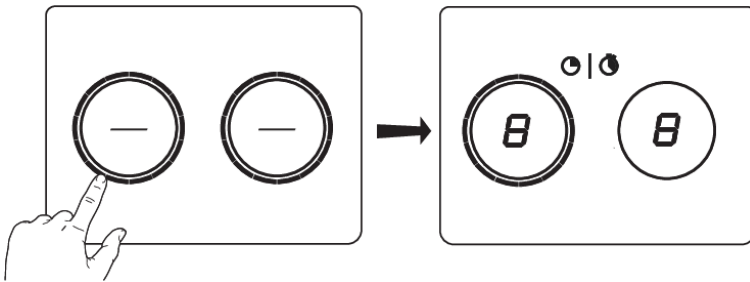

Two adjacent square cooking zones can be merged into a single large cooking zone. Pan position recognition is activated automatically after the appliance is switched on. When a pan will be placed on the hob, the pan recognition function will recognize its position and automatically connect the bridge cooking zones depending on the size of the pan (only when hob was already switched on).

The power level or temperatures are displayed simultaneously on both bridged cooking zones, but the power level or temperature can only be adjusted on the left or upper slider.

You can un-bridge or manually bridge the cooking zone by touching the two corresponding sliders at the same time.

## Chef mode

(only on type models: HID956MC HID956MFC HID956GC)

In this mode, all cooking zones are switched on simultaneously and the cooking hob is divided into three zones.

- On all left-hand side cooking zones, power level 12 is automatically activated.
- On all middle cooking zones, power level 7 is automatically activated.
- On all right-hand side cooking zones, power level 1 is automatically activated.

Power levels can then be adjusted to any value.

# Operation

To activate this mode, touch two sliders at the same time for 3 seconds. All zones must be inactive and Celsius°Cooking™ pans should not be assigned. To turn off this mode, tap any two sliders at the same time.

In this mode, the hob does not warn of an empty cooking zone, even if there is no suitable pan placed on any cooking zone. The hob switches off automatically, if there is no cooking pot detected on the hob for 10 minutes.

## INFORMATION!

Please lift pans when moving them from one zone to another, not slide them.

## Pause



The pause  function can be used to pause the operation of the entire cooking hob for up to 10 minutes. Thus, you can walk away from the appliance or safely clean the cooking hob, within a short period of time, without losing your settings.

### Switching on the pause

At least one cooking zone must be active.

Touch the pause button . You will hear a short beep. The settings on all active hobs are reduced to level 2.

All timer functions are paused.

All keys are inactive except the pause  and on/off  key.

If no key is pressed within 10 minutes, all active hobs automatically turn off.

Hestan Cue programs are not paused since they are automatically operated.

### Switching off the pause

Press the pause key again within 10 minutes.

The hob continues to operate with the same settings as before the break.

Timers are also unpaused.

## Recall function

This feature allows you to recall all the settings of the cooking zones if the hob was accidentally switched off.

Within 6 seconds the hob must be switched back on. Pressing anywhere on the slider within 6 seconds recalls all the settings from before the appliance was last switched off.

## Time functions

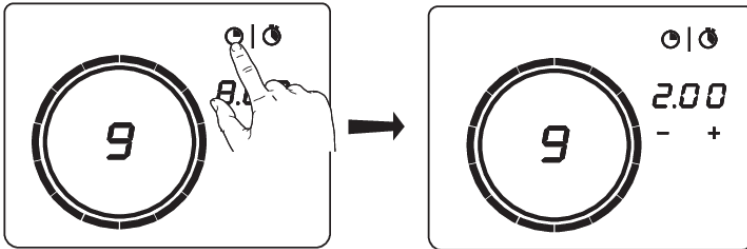

Every cooking zone has two timers: a count-down program timer and a stopwatch (count-up timer).

### **Count-down timer**

The count-down timer makes the cooking process easier by allowing you to set the cooking time for the selected cooking zone. When the time set on the timer expires, the cooking zone will automatically switch off and emit an acoustic signal. Switch off the acoustic signal by touching the count-down timer key ; alternatively, it will switch off automatically after a while. The count-down timer can be set independently for all cooking zones.

#### **Setting the count-down timer**

- Press the count-down timer selector key  for the desired active cooking zone. The key and **0:00** will flash on the cooking zone display unit.
- Set the desired cooking time with **+** and **-**.
- If the time is not set within five seconds, the count-down timer is disabled.
- Repeat the same steps to set the count-down program timer for another active cooking zone.

#### **NOTE!**

If you move the pan from the cooking zone, all timer functions set for that cooking zone will be paused.

#### **Deactivating the count-down timer**

Press the icon  for the selected cooking zone and hold it for 3 seconds. The timer will be switched off.

#### **Deactivating the count-down timer alarm.**

- When the set time expires, alarm will be sounded, the key for the relevant cooking zone will flash, and 0:00 will flash on the count-down timer display unit.
- To acknowledge and stop the alarm, press the count-down timer selector key , or remove the pan from the cooking zone.



## Cooking time display – stopwatch

The stopwatch can be used to see how long you have been continuously cooking on the selected cooking zone and starts counting automatically in the background.

- Press the stopwatch key.
- Stopwatch time will be displayed on the cooking zone display unit.
- Stopwatch can be reset if you press on the stopwatch key for 3 seconds.

## Hot cooking zone

The hot zone symbol  lights up if the cooking zone is inactive, or there is no pan present on the cooking zone while its temperature is higher than 65 °C.

If the hob is switched off and at least one of the cooking zones is still hot, the inner circle remains illuminated. When the temperature of the hob is reduced below 65 °C all lights turn off.

## Overheat protection

- The hob is fitted with a cooling fan which cools the electronic components during cooking. The fan may operate for a while even after the end of the cooking process.
- Induction cooking hob is also fitted with an overheating protector which protects the electronic components from damage. The protector operates in several ways. When the cooking zone temperature gets very high, the cooking power is automatically reduced. If this does not suffice, the cooking zone power continues to decrease, until the safety mechanisms switches off the cooking zone completely. When the cooking hob has cooled off, its total power will be available again.

## ⊕ Cooking with the PLUS menu

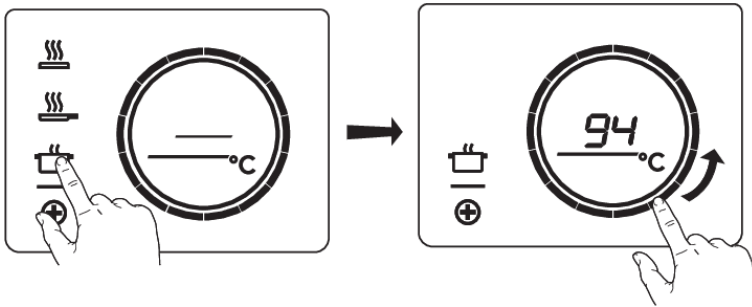

The PLUS menu allows cooking with semi-automatic programs, enabling temperature cooking for all kinds of cookware that fit the purpose of the program.

Touch the PLUS menu key ⊕ to display the program line: keeping warm/heating up, frying/wok and grill (in bridge mode).

Choose one of the Plus programs by touching the relevant symbol. Then you set the temperature with the slider. You can toggle through the menu or temperature by long pressing the relating button too.

When the program or temperature selection does not change for 3 seconds, the program is activated. To deactivate a PLUS program, press the active program key for about three seconds or select a power level manually.

Always add water, oil or butter before starting a program, use no empty pan or pot.

### **Keeping warm and Heating up**

With this function you can for example melt chocolate (45 °C), keep food warm (70 °C), simmer (94 °C) or bring to boil (100 °C).

### **Frying/wok**

With this function you can cook vegetable, fish, bacon, meat, fried potatoes or eggs by using butter or oil.

### **Grill**

This function is exclusively for bridged cooking zones, that are combined to a larger cooking zone.

Grilling is optimized for ASKO induction accessories grill plate and teppanyaki. But it will also work with different cookware, but perhaps less accurate.

Some functions are indicating the heat up time, counting down. In the heating-up stage, the slider and the set temperature will flash. When the set temperature is reached, a short beep will be emitted, and the slider will be constantly lit. You may then start cooking.

The sensor which measures the temperature while cooking within the PLUS menu programs, is located in the glass, below the cookware. Because of this there is always an offset between setpoint and actual temperature of the content inside the cookware. The temperature of the content inside the cookware is therefore also dependent on factors such as: type of pan, volume of liquid and whether a lid is placed on the pan.

# Operation

## INFORMATION!

Up to value 94 °C the programs allow the hob to reach and maintain automatically the set temperature by measuring the glass surface temperature. This will avoid liquids overflowing and burning on the bottom of the pan.

## INFORMATION!

From 100 °C and higher temperatures the programs will heat up cookware with different timed power steps. The set temperature serves as an indication which temperature range can be reached approximately. Cooking process must be attended.

## INFORMATION!

For more accuracy Celsius°Cooking™ cookware such as Frying Pan, Chef's Pot or the Probe is recommend, with separate functions for it (see chapter Celsius°Cooking™).

## INFORMATION!

These menu functions work best if they are started at the beginning of the cooking process. A already hot surface will influence the performance.



## Cooking with Celsius°Cooking™

Your new induction hob is fully packed with smart functions and features that will make cooking easier and more pleasant.

In order to get the most out of these and explore what's possible with Celsius°Cooking™, you can also buy some additional connected equipment that will help you gain total control over temperatures and timings.

This equipment lets you unlock the full power of Celsius°Cooking™, reading and communicating exact information about the temperature of your ingredients, giving perfect results. The equipment is:



**Probe**



**Frying pan**



**Chef's pot**

Find out more at [www.celsiuscooking.com](http://www.celsiuscooking.com), [www.asko.com](http://www.asko.com).

# Operation

## ▶ Cooking with Celsius°Cooking™ cookware and Hestan Cue programs

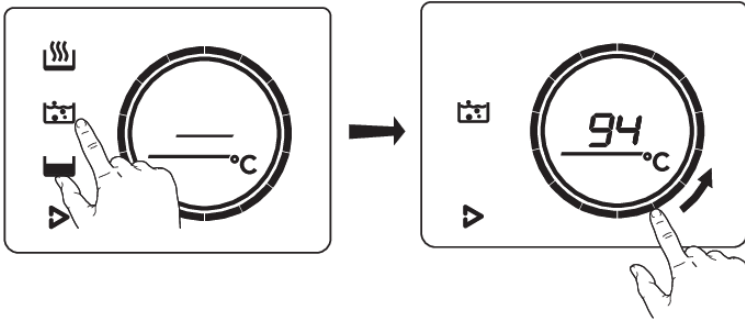

This option involves cooking using either the Celsius°Cooking™ cookware frying pan or pot's that continuously measures the temperature inside the cookware or the Celsius°Cooking™ temperature probe. All use Bluetooth connection to send information about the temperature to the cooking hob.

### Preparing the system

Before you start cooking, please make sure you complete all the preparation steps. Otherwise, you may run into difficulties or inadvertently cause damage to the system.

Using Celsius°Cooking™ ensures you the cookware is always at just the right temperature needed to prepare the food you are cooking.

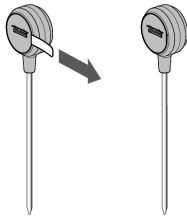

### Prepare Celsius°Cooking™ Probe

1. Pull the battery protection tab out of the Celsius°Cooking™ Probe housing.
2. The Celsius°Cooking™ Probe is ready to be used. If necessary replace the battery.

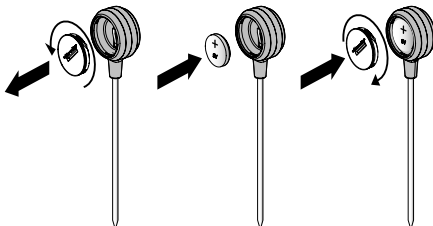

### Battery installation Celsius°Cooking™ Probe

1. Unscrew and remove the battery cover and replace the battery (negative (-) side goes in first).
2. Replace the battery cover. Do not overtighten.

## Insert the Celsius°Cooking™ Probe into a cooking pan

The Celsius°Cooking™ Probe can be used with different types and sizes of pans. Due to the use of a suspension bracket with different holes, the Probe can be suspended in different ways.

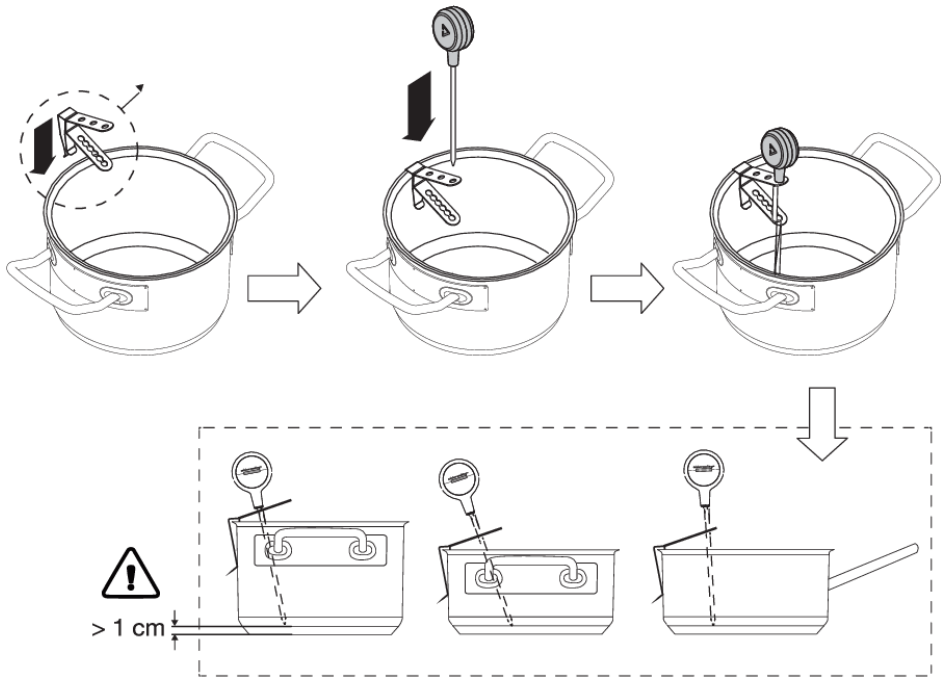

1. Slide the suspension bracket over the pan edge.
2. Slide the Probe pin from the top into the suspension bracket. The tip of the probe should be 1 cm or > from the pan bottom.

### NOTE!

Leave a minimum distance of 1 cm between the pan base and the measuring point of the probe!

### NOTE!

In case the connectivity between cookware and the hob is unstable, this could be due to low battery. In those cases we recommend to change the battery.

# Operation

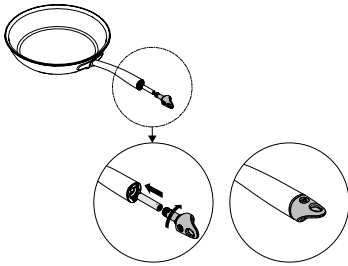

## Celsius°Cooking™ Cookware



1. Insert an AAA battery in the panhandle (negative (-) end goes in first).
2. Insert the handle cap end into the panhandle and turn it a quarter to secure.

### NOTE!

Do not exchange the handle cap of a chef's pot (31620) with that of a frying pan (31619) or vice versa.

## Assigning the cookware to the cooking zone

Switch on the hob and wait until the end of the start up animation

Place the Celsius°Cooking™ cookware or a regular pot fitted with the Celsius°Cooking™ probe on a desired cooking zone. After it has been detected, quickly tap twice with your fingertip on the handle cap sensor or the probe housing to activate it. Right after the Hestan Cue mode key  will light up. To assign the probe the Hestan Cue mode key  will light up on every possible cooking zone. Press the Hestan Cue mode key  on the needed cooking zone. The Hestan Cue menu will be opened. With a short press again it can be closed.

### INFORMATION!

Please make sure that the appliance is already switched on before placing the Celsius°Cooking™ cookware so that the system can clearly identify its position.

## Cooking with the embedded Hestan Cue programs

The hob comes along with integrated Hestan Cue programs, optimized for Celsius°Cooking™ cookware. When cooking with one of the available Celsius Cooking cookware, the possible cooking methods will be shown in the opened menu, which are applicable to the cookware used. Use the one that fits the desired purpose:

### Heating up and frying

This program is to reach high temperatures rapidly. Always add oil or butter before starting it. For healthy cooking don't exceed the smoke point of the used oil.

### Boiling or cooking with water

This program is to reach higher water temperatures quick. Always add water to the cookware before starting it.

### Slow cooking or sous vide

This program is to control low to medium temperatures, preventing high bottom temperatures. Larger quantities and thicker dishes need to be stirred occasionally to ensure a homogeneous heat distribution.

## Using the probe as a cooking thermometer

When a Celsius°Cooking™ probe is used it can also be used as a thermometer to just monitor e.g. the core temperature of a certain dish. This can be done on normal level cooking or PLUS menu programs. To use the probe as thermometer, lift up the pan you want to use for a few seconds, place it back on the zone and activate the probe by tapping. When the Hestan Cue symbol appears on the display, touch it.

The measured temperature is displayed dimmed.

## Probe removal detection

If the probe is moved out during cooking, the hob will detect that and stop heating. When placed back, the user can confirm that by touching the now blinking Hestan Cue mode button, or it might get re-detected automatically.

### NOTE!

e.g. adding cold water to the pot might trigger this detection too!

## Switching off the cooking zone

Touch the slider for the selected cooking zone and hold it for 3 seconds. The sign – will appear on the display.

The cooking zone can also be turned of by pressing the selected Hestan Cue program key and hold it for 3 seconds

## Step-by-Step cooking guide on CelsiusCooking.com

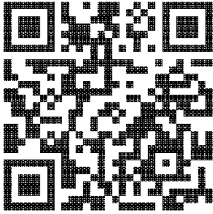

The best tasting food is prepared at the right temperature and for the right length of time. The ability to set temperature instead of power levels supported by how-to (video) guidance lets you create chef-like meals cooked to perfection. The CelsiusCooking.com website is full of inspiring recipes with step-by-step instructions based on chef tested techniques guiding you to prepare delicious, fail proof recipes over and over again.

### **CelsiusCooking.com**

- Whether you are a chef or a beginner, CelsiusCooking.com is going to help you cook better food more often by acting as your guide in the kitchen. You'll learn new techniques, novel combinations, and gain confidence in more difficult dishes. Instead of just cooking at a power level, you will be cooking at an exact temperature level.
- Our recipes lead you through the process of 'Mise En Place' where you'll gather and prepare all of your ingredients in advance. This is particularly important following the recipes on CelsiusCooking.com as each recipe has been carefully timed to give you the perfect results.
- Just follow the steps. The timing and temperature guide will make sure your food is prepared to perfection. It may take some getting used to, but you will end up with an even better meal.

### **Switching off the cooking zone**

Touch the slider for the selected cooking zone and hold it for 3 seconds. The sign – will appear on the display.

The cooking zone can also be turned off by pressing the selected Hestan Cue program key and hold it for 3 seconds

### INFORMATION!

While the Celsius°Cooking™ probe is used to control the temperature of the content inside a pan (e.g. water or soup) the Celsius°Cooking™ cookware is controlled on the pan bottom temperature. Due to this there is always an offset between set-point and actual temperature of the content INSIDE the cookware. When e.g. trying to boil a liquid on the Celsius°Cooking™ cookware it may be necessary to set a higher temperature to reach the boiling point. Reaching the boiling point is also further dependent on the volume of the liquid and whether a lid is placed on top of the cookware. Furthermore, regular stirring improves this behaviour, even when cooking with the probe.

## Hood control

If you own a compatible RF enabled hood, it can be connected to your induction hob. To pair and customize the behaviour of your hood see chapter: Settings. Parameter hth (Hob to Hood) is used for pairing, while Hst and Hsc effect the behaviour of your hood so you can customize it according to your kitchen habits.

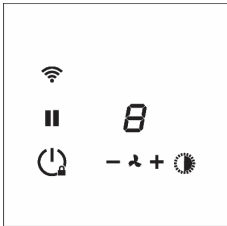

### Switching extraction on and off

- Press the key **+** for a higher fan setting. Press and hold the key **+** for 1 second to select the highest setting.
- Press the key **-** to select a lower setting.

### Switching the light on and off

- Press the light key . The light switches on at maximum strength.
- To turn off the light, press the key again.
- Press and hold the light key to set the lighting intensity.

### Changing the colour lighting temperature

You can adjust the lighting temperature.

- Press the light key together with the **-** key to make the light 'colder' or the light key together with the **+** key to make the light 'warmer'.

### Synchro Start (Settings)

This setting allows the induction hob to automatically activate the lights of the connected hood every time the induction hob is turned on. Depending on the value you set, the ventilation will automatically start at that speed level when any cooking zone is activated.

### Synchro Control (Settings)

In addition to Synchro Start the hood will be controlled automatically depending on the current highest activated cooking level.

### Synchro Stop (Settings)

The lights will be switched off together with the hob and the fan will, with a delay, also be switched off.

## NOTE!

When Synchro Control (see chapter Settings) is enabled a manual operation will deactivate Synchro Control temporarily (hood icons will turn from being dimmed to lit). The function is active again when the hob is switched on next time.

# ConnectLife and Wi-Fi

## 📱 ConnectLife-app and Wi-Fi connection

The hob is equipped with a Wi-Fi module that allows the appliance to connect to the internet via your home network and to use it with the **ConnectLife**-app, installed on a mobile device like a smartphone or tablet.

The app is available on the Apple App Store and Google Play Store. You will need the app to connect the hob to your network. After your user account is paired with the cooking hob, the app can be used to monitor the status of the cooking hob and enables to update its firmware (see chapter 'Firmware Update').

You can find direct links for the different stores to the **ConnectLife**-app under [www.connectlife.io/getstarted](http://www.connectlife.io/getstarted) and more information about the system, support, available functionalities and additional options under [www.connectlife.io](http://www.connectlife.io).

For safety reasons, it is not possible to remotely control, turn on or turn off the hob.

### Preparation

- Make sure you know the name/SSID of your router's Wi-Fi network and its password<sup>1)</sup>.
- Make sure you have the label with the QR code of the appliance unique ID ('AUID') accessible – you need to scan it with your mobile device when the App prompts to do so.
- Make sure that Wi-Fi is activated on the hob by checking if the Wi-Fi key is visible when the hob is on.

Else see "Activate Wi-Fi".



- Install the **ConnectLife**-app on a mobile device – scan the QR code to find it.
- Launch the App. Please register if you don't have an account yet.
- Log in with your account.
- The App will need access the mobile's location to search for Wi-Fi networks and to the camera to scan QR codes.

### Wi-Fi Connection setup

You will first connect your mobile device directly to the appliance via Wi-Fi, and then use this connection to share the data of your Wi-Fi home network. The hob can then connect to the home network.

1. Launch the **ConnectLife**-app.
2. Select "Add appliances" in "Appliances", choose "Hob", and follow the instructions.
3. Scan the QR code with the AUID code when asked or type it in.

#### Proceed on the appliance:

4. Switch on the hob.
5. Touch the Wi-Fi key for 3 seconds to enter the Wi-Fi menu (only possible when NOT cooking).
6. When 'C' (connection) Connection Setup Mode is shown in the display, touch the Wi-Fi key to activate the Connection setup. When 'C' flashes the Connection setup<sup>2)</sup> starts.

<sup>1)</sup> NOTE: only 2,4Ghz networks are supported

<sup>2)</sup> NOTE: will be deactivated after 5 minutes when unsuccessful



## Proceed on the mobile device in the ConnectLife-app:

7. Connect your mobile device to the Wi-Fi network of the appliance when asked.
8. When your mobile asks whether to keep the connection, despite no internet connection, choose yes.
9. Follow the instructions in the **ConnectLife**-app.

The user account signed in on the mobile device used for the Connection setup will automatically be paired with the cloud. If you'd like to pair another account, e.g. on a second user's mobile device see "Pairing additional user".

For safety reasons, only paired users can communicate with the hob.

## Activate Wi-Fi

1. Switch off the hob.
2. Touch the on/off key for 5 seconds.
  - *A short beep will be emitted. The Wi-Fi key will appear.*

## Wi-Fi menu

Activate Wi-Fi to enable the Wi-Fi menu. The hob must be switched on.

1. Touch the Wi-Fi key for 3 seconds to open the Wi-Fi menu.
  - *Depending on the Wi-Fi state, there are 1 to 3 options available in the menu: 'C' (connection) to set up a connection, 'P' (pair) to pair an additional user, and 'U' (unpair) to unpair all users.*
2. Use the + (plus) and - (minus) keys to switch between them, if more than 1 option is available.
3. Touch the Wi-Fi key to confirm the selected option.
4. Touch the on/off key or touch the slider to close the menu.
  - *If no key is pressed within 60 seconds, the menu will be switched off automatically.*

## Connection setup

1. Select option '**C**' in the Wi-Fi menu.
  - *The appliance is in "Connection Setup Mode" for 5 minutes.*
  - '**C**' will flash, and the + (plus) and - (minus) keys will be switched off.
2. On the mobile app, start the process to 'Add appliances' and follow the instructions to pair the appliance.

## Pairing additional user

This option requires that the connection setup has been performed successfully and the hob is connected to the cloud (Wi-Fi key is constantly full lit).

1. Select option '**P**' in the Wi-Fi menu.
  - *The appliance is in "Pairing Mode" for 3 minutes.*
  - *The Wi-Fi key will flash, and the + (plus) and - (minus) keys will be off.*
2. On the mobile app, start the process to 'Add appliances' and follow the instructions to pair the appliance.

# ConnectLife and Wi-Fi

## Unpair all users

This option requires that the connection setup has been performed successfully and the hob is connected to the cloud (Wi-Fi key is constantly full lit).

1. Select option '**U**' in the Wi-Fi menu to unpair all users and disconnect from the cloud.
  - *The Wi-Fi key will flash 3 times.*
  - *The hob will delete all paired users and disconnects from the cloud ("unpair").*

## Switching off Wi-Fi

1. Enter the Wi-Fi menu as explained in 'Wi-Fi menu'.
2. Touch the Wi-Fi key for 3 seconds to deactivate Wi-Fi.
  - *A short beep will be emitted. The Wi-Fi key will be off.*

The cooking hob, equipped with a Wi-Fi module, can receive updates of the appliance firmware (for example improved function updates or safety relevant updates). This requires, that the cooking hob is connected to the cloud and ConnectLife app with a registered user account. If this is not yet established, please proceed with the chapter for Wi-Fi Connectivity.

When a new firmware is available, a notification is sent to the ConnectLife app. Please follow the instructions given on the mobile app.

To start the update process, the cooking hob needs to have the **FoA** setting set to **ON** in the settings menu (see chapter Settings). This confirms your presence at the cooking hob. After 90 minutes, this setting is automatically reset to **OFF**.

After the **FoA** setting on the cooking hob is set to ON, start the update process on your mobile app.

The cooking hob will switch off. As indication, the Wi-Fi symbol  flashes during the process. Depending on the configuration, the update process can take up to 60 minutes.

## NOTE!

During the update process, the hob cannot be used. Make sure, the power supply and Wi-Fi connection are not terminated. The update process may take a while. It is normal, if there may be no response during the update or the cooking hob is restarting multiple times.

In case, the process failed, the cooking hob remains on the previous firmware version and should operate as normal. Please wait for some time before trying again. If the process continues to fail, contact the service department for further support.

If the hob is not responding after the update process, please wait for some time, the cooking hob might be still in the update process. If there is still no response after multiple hours, contact the service department for further support.

# Settings

You can tailor the behaviour of this induction hob to suit your cooking style! There are various settings available for adjustment.

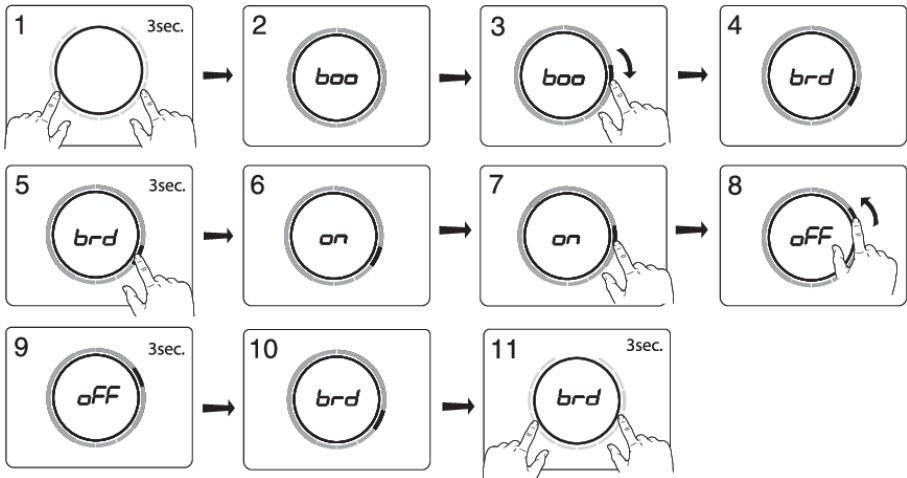

While there are no pans on any zone, touch any slider with two fingers and keep it pressed for 3 seconds. Different settings can now be toggled through using the slider. To view or change a particular setting, touch the slider element of the slider with one finger and keep it pressed for 3 seconds. Now you can choose to change or disable that setting. To do this, toggle to the desired value. After 3 seconds of inactivity the new setting will be confirmed.

## NOTE!

A change to 'current limiter' setting (CON) can only be confirmed or accepted by a 3 second-press after step 9, in order to avoid unintentional adjustment. A change without confirmation will not be applied!

To exit the menu, press with two fingers anywhere on the slider for 3 seconds.

### The following settings are available (depending on the model).

<p><b>boo</b> - Auto boost Automatic Boost activation</p>	<p>While on, boost is automatically activated when power level 12 is activated. While off, the boost is activated by sliding past the power level 12 or touching power level 12 twice.</p>
<p><b>brd</b> - Auto bridge Automatic cooking zone bridging</p>	<p>While on, when a new pan is detected on two bridgeable cooking zones, the cooking zones are automatically bridged into one big cooking zone. While off, bridging must be done manually by pressing on the sliders of two bridgeable cooking zones at the same time.</p>
<p><b>rEC</b> - Recovery function Recovery function</p>	<p>While on, recovery function is active and settings can be moved from one cooking zone to the other when a pan switches position.</p>

<p><b>AtI</b>- Auto timer Automatic stopwatch timer</p>	<p>While on, stopwatch (count-up timer) starts counting in the background whenever a cooking zone is activated. While off, stopwatch must be activated manually and starts counting from 0:00.</p>
<p><b>ACL</b> - Auto child lock Auto child lock</p>	<p>While on, the hob is automatically locked at every switch off.</p>
<p><b>Snd</b> - Sound volume Sound volume</p>	<p>Sound volume has 4 different options. L3 (high), L2 (medium), L1 (low), off (only error and alarm sounds).</p>
<p><b>Sen</b> - Key sensitiveness Key responsiveness</p>	<p>Key responsiveness has 3 different speed options. L3 (quick), L2 (medium), L1 (slow).</p>
<p><b>hth</b> - Hob-to-hood pairing (RF) Hood control</p>	<p>If you own a compatible hood with RF connectivity, you can pair it with your induction hob! To do so, set this parameter to on. Hood control icons will start blinking. You now have 5 minutes to activate the pairing on your RF hood. Once the hood is paired with your induction hob, the hood control icons will stop blinking. If you wish to unpair the hood, set the hth parameter again to off.</p>
<p><b>hSt</b> - Hob-to-hood (Synchro Start Level) Hood Start Level</p>	<p>This setting allows the induction hob to automatically activate the lights of the connected hood every time the induction hob is turned on. Depending on the value you set, the ventilation will automatically start at that speed level when any cooking zone is activated.</p>
<p><b>hSC</b> - Hob-to-hood (Synchro Control response Level) Hood response Level</p>	<p>This setting allows the induction hob to automatically activate the lights of the connected hood every time the induction hob is turned on. While on, the hood will be controlled automatically depending on the current highest activated cooking level. If you manually change any hood related settings, the hood turns to manual control for the rest of this cooking session. The response level can be set: L3 (high), L2 (medium), L1 (low), off.</p>
<p><b>hSp</b>- Hob-to-hood (Synchro Stop Level) Hood Stop Level</p>	<p>This setting allows the induction hob to automatically deactivate the lights of the connected hood every time the induction hob is turned off. Depending on the value you set, the ventilation will switch to that speed level and stop with a delay.</p>
<p><b>btP</b> - Bluetooth pairing Bluetooth device pairing</p>	<p>To pair a bluetooth device, set this setting to on. You now have 3 minutes to pair a new bluetooth device to this induction hob.</p>
<p><b>btC</b> - Bluetooth clear Bluetooth clear paired devices</p>	<p>To unpair all the bluetooth devices, set this setting to Clr. All your connected bluetooth devices are now unpaired.</p>
<p><b>Fir</b> - Display firmware version</p>	<p>To display the current software versions of the hob. The UI software version and the Celsius°Cooking™ software version will be shown in alternating order.</p>

# Settings

<p><b>FoA</b> - Firmware update over the air</p>	<p>To receive firmware updates for the cooking hob, you need to be paired to the cooking hob via the mobile app. You will receive a notification, or you can check available firmware updates on the mobile app menu for updates.</p> <p>In order to start the firmware update via the mobile app, set this setting to on to confirm your presence at the cooking hob. For more information see chapter Firmware Update. After 10 min, this setting is automatically reset to off.</p>
<p><b>dE</b> - Demo Mode (Demo Mode for Dealer Showrooms)</p>	<p>In demo the appliance will act as usual, without the possibility to heat the cookware.</p> <p>When set this will be indicated after switching on the appliance with a short "d" indication;</p> <p>Without any user interaction the appliance will automatically switch off after 10 minutes.</p>
<p><b>Con</b> - connection power Current limiter</p> <p><b>NOTE!</b></p> <p>To prevent unintentional adjustment of the 'CON - connected power', CON setting must be confirmed when changed by touching the slider for 3 seconds. A change without confirmation will not be implemented!</p>	<p>If your electrical wiring or circuit breakers do not meet the specified current draw on the rating plate, the current limiter can be activated by reducing the value of this setting. Doing so may cause a reduced performance of the induction hob.</p> <p>The following numbering format of the setting is available: X.XX. The number left of the dot represents the number of connected phases, while the number right of the dot represents the electrical current per phase in Ampere.</p> <p><b>⚠ WARNING!</b></p> <p>The appliance must always be set to the actual or lower rating of the electrical wiring or circuit breakers. This setting can only be set by an authorised expert.</p>

## Cleaning

### INFORMATION!

Set the locking function before you start cleaning the hob. We recommend that you clean the appliance after each use. This prevents that over cooked food can damage the glass surface.

#### **Daily cleaning**

1. Use a damp cloth and a mild cleaning agent (washing-up liquid) to clean the appliance.
2. Dry the appliance with a paper towel or a cloth.

#### **Heavily polluted glass**

1. Immediately remove any food remains, burned grease, sugar or stubborn stains from the hob using a scraper, even if the hob is still hot! Sugar and/or other food related remains may permanently damage the glass ceramic surface.
2. Hold the scraper at the correct angle (45° to 60°) in relative to the glass. Gently press the scraper against the glass and slide it over the surface to remove the dirt. Make sure the plastic handle of the scraper (in some models) does not meet with a hot cooking zone. Do not press the scraper perpendicularly against the glass. Do not scratch the hob surface with the tips of the scraper blade. This can cause permanent scratches in the glass.
3. After you have removed the stubborn stains from the glass, use the steps of the daily cleaning to clean the hob.
4. If necessary a special intensive cleaner for ceran/induction hobs can be used.
5. If the cleaning result is not at your satisfaction you can repeat the above cleaning steps as often as needed or check [www.atagservice.nl](http://www.atagservice.nl) for additional cleaning information.

### WARNING!

Do not use abrasive cleaning agents, because they can cause scratches. Do not use steelwool, scourers or any type of sharp objects to clean the appliance.

### WARNING!

The hob can be still very hot due to the cooking process! Do not touch the surface directly. If desired use oven gloves to prevent burning while cleaning directly after cooking.

# Troubleshooting

## General

If you notice a crack in the glass top (however small), switch the hob off immediately, unplug the hob, turn off the (automatic) fuse switch(es) in the meter cupboard or, in the event of a permanent connection, set the switch in the power supply lead to zero. Contact the service department.

### Troubleshooting table

If the appliance does not work properly, this does not always mean that it is defective. Try to deal with the problem yourself first by checking the points mentioned below or check the website for more information.

Symptom	Possible cause	Solution
A slight smell is noticeable the first few times the hob is used.	The new appliance is heating up for the first time.	This is normal and will disappear once it has been used a few times. Ventilate the kitchen.
The pans make noise while cooking.	This is caused by the energy flowing from the hob to the pan.	At high settings this is perfectly normal for some pans. It will not damage either the pans or the hob.
Circle of pan bottom remains visible after cleaning.	Contaminated pan bottom used on the cooking zone.	Clean the induction hob with a ceramic hob cleaner and remove the dirt / grease from the pan bottom.
A cooking zone suddenly stops working and you hear a signal.	The pre-set time has ended.	Switch off the beeping by touching the cooking zone blinking timer key.
The hob is not working and nothing appears in the display.	There is no power supply due to a defective cable or a faulty connection.	Check the fuses and the electric switch and the power socket.
A fuse blows as soon as the hob is switched on.	The hob has been wrongly connected.	Check the electrical connections.
Hestan Cue key is blinking, together with set cooking method key and display	Celsius°Cooking™ cookware is assigned to wrong cooking zone.	Solution: remove cookware and assign again.
Set Hestan Cue cooking method key is blinking together with set temperature display while using the probe	Celsius°Cooking™ Probe is removed or not in touch with the content. Or the temperature has fallen rapidly, e.g. due to adding cold water.	Place Probe back or reposition - press cooking method key if probe isn't auto detect.
Unstable connection between cookware and hob	Low battery of cookware or unstable bluetooth connection	Switch off the cooktop for 10 seconds and/or change the battery



Error code	Symptom	Possible cause	Solution
U400	U 400 appears on display with continuous sound tone.	Voltage of the mains is too high.	Connect the appliance in accordance to rating plate and instructions.
E2	E2 appears on display.	Empty pan was heated on the cooking zone.	Wait for cooking zone to cool down or fill the pan with foodstuff.
Er03	Er03 appears on display.	One of the controls is pressed to long. Or there is water, dirt or a pan on the controls.	Clean the control panel.
E7	E7 appears on display after doing the Wi-Fi connection setup.	Connection Setup failed.	Retry connecting the appliance to your network. Make sure that new devices may connect to it (e.g. MAC-address filtering is deactivated).
E65	E65 appears on display, together with Hestan Cue is blinking	Non-Celsius°Cooking™ cookware is not supported	Use Celsius°Cooking™ cookware
E66	E66 appears on display, together with Hestan Cue is blinking.	Celsius°Cooking™ cookware was not found (empty battery, out of range, etc.).	Replace battery - check the status with the Hestan App when unsure.
E67	E67 appears on display, together with Hestan Cue key is blinking.	Celsius°Cooking™ cookware missing.	If handle cap is mounted correctly; Replace battery - check the status with the Hestan App when unsure.
E8	E8 appears on display	Ventilator is blocked (eg possible by item in the drawer)	Unblock the ventilator; disconnect appliance from main voltage for 10 sec
☄	Zone stops unintended and residual heat indicator is shown	Zone is overheated	After the hob has cooled down, cooking can be continued

## NOTE!

In case of other error codes: please write down the error code and contact the service department.

# Troubleshooting

## Troubleshooting Wi-Fi

Symptom	Possible cause	Solution
Wi-Fi icon not shown	Wi-Fi disabled	The hob must be switched off, then touch the on/off key  and hold it for 5 seconds.
Wi-Fi setup failed	Home network issues.	Check that your home network signal is strong and internet connection is working.
Home network is not displayed during the connection setup process.	Home network is not on 2.4 GHz, the network is hidden, or signal strength is too weak.	Please check the network settings. Ensure a 2.4 GHz and visible network. If the signal is too weak, try to move the network router closer.
Cooking hob is shown disconnected on the mobile app	Wi-Fi is disabled or Home network issues.	Ensure the Wi-Fi is enabled, and internet connection of your home network is working. Repeat the connection setup if needed.
Other Wi-Fi issue	Different causes.	First disable and enable again the Wi-Fi. Ensure internet connection of your home network is working. Repeat the connection setup if needed. Further troubleshooting available on <a href="http://www.connectlife.io">www.connectlife.io</a> or contact the service department.
Firmware update process failed.	Internet connection lost or power supply terminated.	Ensure the power supply is not terminated and a stable internet connection before retrying again. If failed again, contact the service department.

## **Safety**

If the safety instructions and warnings are not followed, the manufacturer cannot be held responsible for any resulting damage.

- This appliance should only be connected by a registered installer.
- Check the appliance for transport damage. Do not connect a damaged appliance.
- The walls and the worktop surrounding the appliance must be heat resistant up to at least 85 °C. Even though the appliance itself does not get hot, the heat of a hot pan could discolour or deform the wall.
- The worktop into which the hob is fitted should be flat.
- The air must not be discharged into a flue that is used for exhausting fumes from appliances burning gas or other fuels (not applicable to appliances that only discharge the air back into the room).
- Extraction hoods and other appliances that extract cooking vapours can affect the safe operation of appliances that burn gas or other fuel (including those in other rooms) by backflowing combustion gases. These gases can potentially lead to carbon monoxide poisoning. After installing an extraction hood or other vapour extractor, the operation of appliances with flue gas extraction must be tested by a competent person to ensure that the combustion gases do not flow back.
- Local regulations concerning the discharge of air have to be fulfilled.
- For stationary appliances permanently connected to the fixed wiring, compliance with this requirement is considered to be met if the instruction concerning disconnection incorporated in the fixed wiring is in accordance with AS/NZS 3000.

## **Electrical connection**

- This appliance must be earthed.
- The electrical connection must comply with national and local regulations.

# Installation

- Prior to installation, ensure that the local distribution conditions (voltage and frequency) and the adjustment of the appliance are compatible.
- Means for disconnection must be incorporated in the fixed wiring in accordance with the wiring rules.
- The voltage, frequency, power and the country for which the appliance has been designed are shown on the appliance rating plate.
- For class I appliances, check that your home's electrical system provides proper earthing.
- The wall plug socket and plug should always be accessible.
- If a stationary appliance is not fitted with a supply cord and a plug, or with other means for disconnection from the supply mains having a contact separation in all poles that provide full disconnection under overvoltage category III conditions, the means for disconnection must be incorporated in the fixed wiring in accordance with the wiring rules. This is also applicable for appliances with a supply cord and plug when the plug is not accessible after installing the appliance. Using an omnipolar switch with a contact separation of at least 3 mm fitted in the fixed wiring will fulfil this requirement.
- The connection cable must hang freely and should not be fed through a drawer.
- For connecting, use an approved cable with the correct cable diameters appropriate for the connection. The cable casing should be made of rubber (preferably of the H05V2V2 or H07V2V2 type).
- Before connecting the appliance, make sure the voltage indicated on the rating plate conforms to the voltage in your power mains.
- The connection should be adjusted to the current and fuses.
- The appliance should not be connected to the mains via a multi-plug adapter or extension cable, as the safe use of the equipment cannot be guaranteed.
- After installation, the parts carrying electrical current and insulated parts shall be protected against contact.

## WARNING!

Failure to use screws or fasteners for installation as described in the installation instructions may result in electric shock.

### Service

- Disconnect the appliance from the mains supply before starting any repair work.
- Faulty parts may only be replaced by original parts.  
The manufacturer can only guarantee that original parts meet safety requirements.
- If the supply cord is damaged, it must be replaced by the manufacturer, its service agent or similarly qualified persons in order to avoid a hazard.

### Installing a built-in hob

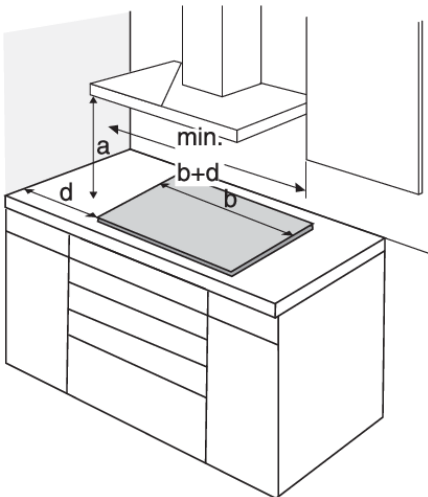

Use of solid wood corner trims on worktops behind the cooking hob is only allowed if the clearance between the trim and the cooking hob is no smaller than indicated on the installation plans.

a (mm)	b (mm)	d (mm)
600	380	40
600	640	40
600	720	40
600	800	40
600	900	40
600	1110	40

# Installation

## Dimensions

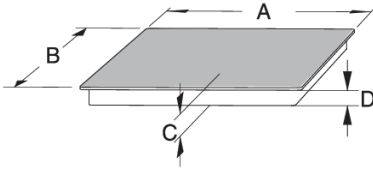

	A (mm)	B (mm)	C (mm)	D (mm)
38 cm	384	522	50	46
64 cm	644	522	50	46
72 cm	724	522	50	46
80 cm	804	522	50	46
90 cm	904	522	50	46
111 cm	1114	412	50	46

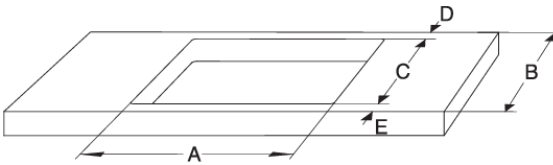

	A (mm)	B (≥mm)	C (mm)	D (≥mm)	E (≥mm)
38 cm	350-352	600	490-492	40	50
64/72 cm	560-562	600	490-492	40	50
80 cm	750-752	600	490-492	40	50
80 cm - 5 zones	770-772	600	490-492	40	50
90 cm	860-862	600	490-492	40	50
111 cm	1070-1072	500	385-387	40	50

## Air vents in the lower kitchen cabinet

- Normal operation of the induction cooking hob electronic components requires sufficient air circulation.

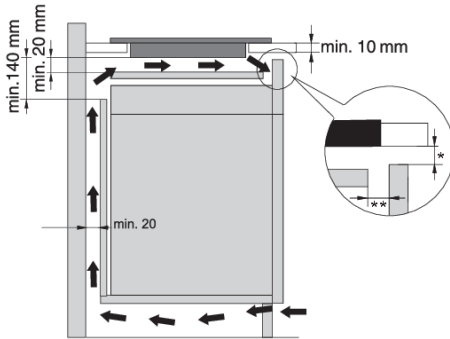

### Lower cabinet without an oven

- There must be an opening with a height of no less than 140 mm along the entire width of the cabinet in the cabinet rear wall.
- A horizontal partition panel should be installed underneath the induction hob along its entire length. There should be at least 20 mm of clearance between the lower end of the appliance and the partition panel. Adequate ventilation should be allowed from the rear side.

- The hob is fitted with a fan located in its lower part. If there is a drawer underneath the countertop, do not use it to store small objects or paper as these could, if sucked into the fan, damage the fan and the cooling system. Moreover, do not use the drawer to store aluminium foil or flammable substances or liquids (such as sprays). Keep such substances away from the cooking hob. Danger of explosion! There should be at least 20 mm of clearance between the contents of the drawer and the fan inlet vents.

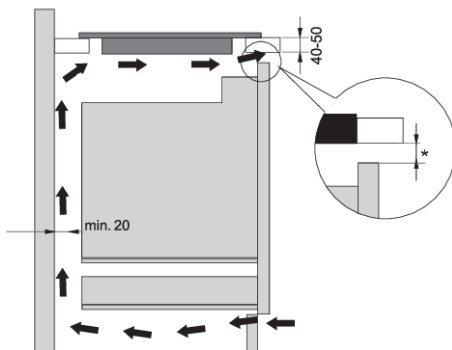

### Lower cabinet with an oven

- Only install ovens with a cooling fan under the induction hob. Before installing the oven, the kitchen cabinet rear wall has to be removed in the area of the opening for installation. In addition, there should be an opening of at least 6 mm in the front side, along the entire width of the cabinet.
- If other appliances are installed under the induction cooking hob, we cannot guarantee their correct operation.

\* For optimal hob performance, a ventilation gap of  $\geq 6$  mm is advised.

\*\* A gap of 20 mm is recommended at the front between the cabinet and intermediate shelf for better ventilation of the hob.

# Installation

## Flush-mount installation into the worktop

Appliances without faceted edges or decorative frames are suitable for flush mounting.

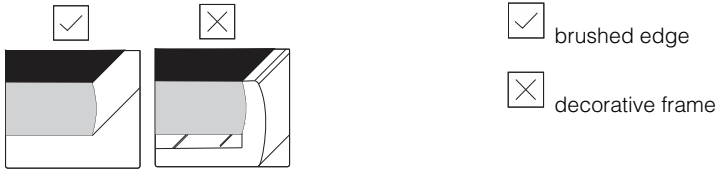

### Installing the appliance

The appliance may only be installed into a temperature- and water-resistant countertop, such as a countertop made of (natural) stone (marble, granite), or solid wood (the edges along the cut-out have to be sealed). When installing into a countertop made of ceramics, wood, or glass, a wooden sub-frame should be used. The frame is not supplied with the appliance. Internal dimension of the basic unit should be at least equal to the internal cutout for the appliance. Only in this way the appliance can be serviced from the underside in case a problem might occur. Attach sealing tape along the perimeter of the bottom of the glass panel.

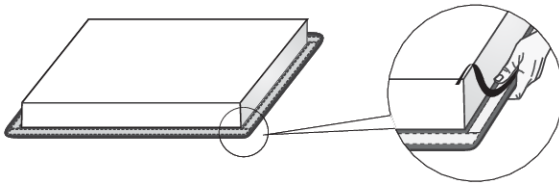

First, feed the power cord through the cutout. Place the appliance over the centre of the cutout. Connect the appliance to the power mains (see chapter Technical installation). Before sealing the appliance, test its operation. Seal the slot between the appliance and the countertop using a silicone sealant. The silicone sealant used to seal the appliance has to be temperature-resistant (to at least 160 °C). Smooth out the silicone sealant using a suitable tool. Observe the instructions for use of the selected silicone sealant. Do not switch on the appliance until the silicone sealant has dried completely.



### **⚠ WARNING!**

Pay particular attention to built-in dimensions with (natural) stone countertops. When choosing the silicone sealant, observe the countertop material and consult the countertop manufacturer. Use of inappropriate silicone sealants can result in permanent discolouration of some parts.



## Removing the built-in appliance

Disconnect the appliance from the power mains. Use a suitable tool to remove the silicone gasket from the perimeter. Remove the appliance by pushing it upwards from the bottom side.

### WARNING!

Do not attempt to remove the appliance from the upper side of the counter!

### WARNING!

The service department shall only be responsible for repair and servicing of the cooking hob. Consult your specialized kitchen equipment dealer regarding the re-installation of the flush-mount cooking hob.

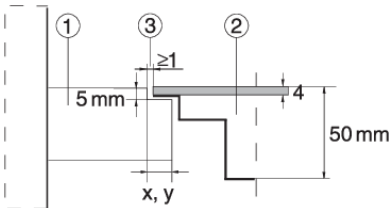

### Stone countertop

1. Countertop
2. Appliance
3. Slot

Given the margin of error (tolerance) for the glass ceramic plate of the appliance, and the cutout in the countertop, the slot is adjustable (min. 2 mm).

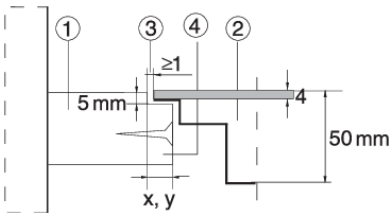

### Ceramic, wooden, or glass countertop

1. Countertop
2. Appliance
3. Slot
4. Wooden frame, thickness 16 mm.

# Installation

Installation into the worktop - flush mount (depending on the model)

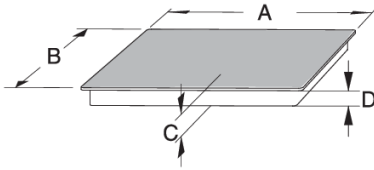

	A (mm)	B (mm)	C (mm)	D (mm)
72 cm	720	510	50	46
80 cm	800	510	50	46
90 cm	900	510	50	46
111 cm	1110	410	50	46

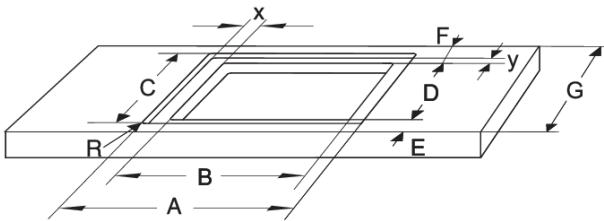

	A (mm)	B (mm)	C (mm)	D (mm)	E (≥mm)	F (≥mm)	G (≥mm)	R	X	Y
72 cm	724-725	560-562	514-515	490-492	50	40	600	6	82	12
80 cm (4 zone)	804-805	750-752	514-515	490-492	50	40	600	6	27	12
80 cm (5 zone)	804-805	770-772	514-515	490-492	50	40	600	6	17	12
90 cm	904-905	860-862	514-515	490-492	50	40	600	6	22	12
111 cm	1114-1115	1070-1072	414-415	385-387	50	40	500	6	22	14

## ⚠ WARNING!

If the oven is installed under a flush-mounted cooking hob, then the worktop thickness should be at least 38 mm.

## ⚠ WARNING!

The service department shall only be responsible for repair and servicing of the cooking hob. Consult your specialized kitchen equipment dealer regarding the re-installation of the flush-mount cooking hob.

## Fitting the foam gasket

### ⚡ INFORMATION!

Some appliances come with the gasket already fitted!

Before installing the appliance into a kitchen worktop, attach the foam gasket supplied with the appliance to the bottom side of the glass ceramic hob.

- Remove the protective film from the gasket.
- Attach the gasket to the bottom side of the glass (2–3 mm away from the edge). The gasket has to be applied along the entire edge of the glass. The gasket may not overlap in the corners.
- When fitting the gasket, make sure it is not damaged by or in contact with any sharp objects.

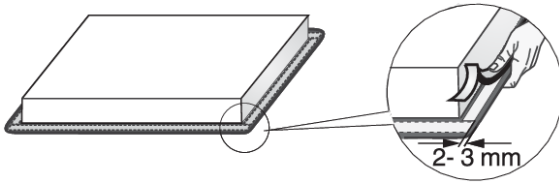

### ⚠ WARNING!

Do not install the appliance without this gasket!

- The worktop has to be completely level.
- Protect the cut out surfaces.

# Electrical installation

## Connecting the cooking hob to the power mains

- Power mains protection must conform to the relevant regulations.
- Before connecting the appliance, make sure the voltage indicated on the rating plate conforms to the voltage in your power mains.
- There should be a switching device in the electrical installation that can disconnect all poles of the appliance from the power mains, with a minimum clearance of 3 mm between the contacts when open. Suitable devices include fuses, protective switches etc.
- The connection should be adjusted to the current and fuses.
- After installation, the parts carrying electrical current and insulated parts shall be protected against contact.

## Connection

1. Check the voltage. Before connecting the appliance, make sure the voltage specified on the rating plate conforms to the voltage of your power mains. The voltage of your power mains (220–240 V between L and N) should be checked by an expert using an appropriate measuring device.
2. Open the cover of the connection terminal box.
3. Connect the wires according to your type of appliance.
4. The jumpers are provided separately.
5. Change the power limitation in the Settings when needed. See chapter Settings **Con** for connection setting.

### WARNING!

The appliance may only be connected by an authorised expert. False connection can destroy parts of the appliance. In such case, there is no right to warranty. Disconnect the appliance from the power mains before any repair or maintenance operation.

### **Power cord**

- Run the power cord through a cord strain relief (clamp) which protects the cable from being pulled out.

### **Connection diagram**

For appliance types: BI3CA... .

### NOTE!

Note: The appliance type can be found on the rating plate on the bottom of the appliance.

Power cord core cross sectional area should be at least 1,5 mm<sup>2</sup> for the following current limiter settings which should be adjusted to your circuit breakers:

Current limiter settings	Connection type	Power cord type	Number and cross section of Power cord wires
1x16A	1 phase, 1 neutral conductor	H05V2V2-F	3x1,5 mm <sup>2</sup>
1x13A	1 phase, 1 neutral conductor	H05V2V2-F	3x1,5 mm <sup>2</sup>
1x10A	1 phase, 1 neutral conductor	H05V2V2-F	3x1,5 mm <sup>2</sup>
1x06A	1 phase, 1 neutral conductor	H05V2V2-F	3x1,5 mm <sup>2</sup>

Voltage between line and neutral conductor must be 220–240 V~.



1 phase, 1 neutral conductor (220–240 V~, 50-60 Hz)

**L** = black/brown

**N** = blue

 = yellow-green

For appliance types: BI1CA..., BI6CA..., BI6CB..., BI7CA..., BI8CA..., BI8CB..., BI9CE...

## NOTE!

Note: The appliance type can be found on the rating plate on the bottom of the appliance.

Voltage between line and neutral conductor must be 220–240 V~. Voltage between lines must be 380–415 V~. Power cord core cross sectional area should be at least as listed in Table for the following current limiter settings which should be adjusted to your circuit breakers:

Current limiter settings	Connection type	Power cord type	Number and cross section of Power cord wires
2x16A	2 phases, 1 neutral conductor	H05VV-F	4x1,5 mm <sup>2</sup>
2x13A	2 phases, 1 neutral conductor	H05VV-F	4x1,5 mm <sup>2</sup>
2x10A	2 phases, 1 neutral conductor	H05VV-F	4x1,5 mm <sup>2</sup>
2x06A	2 phases, 1 neutral conductor	H05VV-F	4x1,5 mm <sup>2</sup>
2x16A	2 phases, 2 neutral conductors (only for NL)	H05VV-F	5x1,5 mm <sup>2</sup>
1x32A	1 phase, 1 neutral conductor	H05VV-F	3x4,0 mm <sup>2</sup>
1x25A	1 phase, 1 neutral conductor	H05VV-F	3x4,0 mm <sup>2</sup>
1x20A	1 phase, 1 neutral conductor	H05VV-F	3x4,0 mm <sup>2</sup>
1x16A	1 phase, 1 neutral conductor	H05VV-F	3x4,0 mm <sup>2</sup>
1x13A	1 phase, 1 neutral conductor	H05VV-F	3x4,0 mm <sup>2</sup>
1x10A	1 phase, 1 neutral conductor	H05VV-F	3x4,0 mm <sup>2</sup>
1x06A	1 phase, 1 neutral conductor	H05VV-F	3x4,0 mm <sup>2</sup>

# Electrical installation

The following connections are possible.

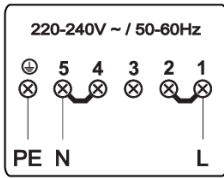

1 phase, 1 neutral conductor (220–240 V~, 50-60 Hz)

To reach the rated maximum power a fuses of 32A is needed.

Install a jumper between terminals 1 and 2 and between terminals 4 and 5.

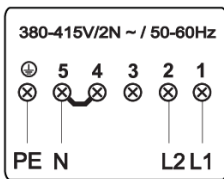

2 phases, 1 neutral conductor (380–415 V 2N~, 50-60 Hz)

To reach the rated maximum power two fuses of 16A are needed.

Install a jumper between terminals 4 and 5.

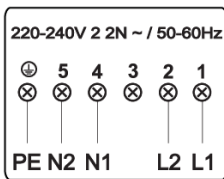

(only for NL)

2 phases, 2 neutral conductors (220–240 V 2-2N~, 50-60 Hz)

To reach the rated maximum power two fuses of 16A are needed.

The 2 fuses (L1 and L2) should be secured by only one and the same earth leakage breaker. It is not allowed to run L1/N1 throu a different earth leakage breaker than L2/N2.

For appliance types: BI9CA..., BI9CB..., BI9CC....

## NOTE!

Note: The appliance type can be found on the rating plate on the bottom of the appliance.

Voltage between line and neutral conductor must be 220–240 V~. Voltage between lines must be 380–415 V~. Power cord core cross sectional area should be at least as listed in Table for the following current limiter settings which should be adjusted to your circuit breakers:

Current limiter settings	Connection type	Power cord type	Number and cross section of Power cord wires
3x16A	3 phases, 1 neutral conductor	H05V2V2-F	5x1,5 mm <sup>2</sup>
3x13A	3 phases, 1 neutral conductor	H05V2V2-F	5x1,5 mm <sup>2</sup>
3x10A	3 phases, 1 neutral conductor	H05V2V2-F	5x1,5 mm <sup>2</sup>
3x06A	3 phases, 1 neutral conductor	H05V2V2-F	5x1,5 mm <sup>2</sup>
2x16A	2 phases, 1 neutral conductor	H05V2V2-F	4x1,5 mm <sup>2</sup>
2x13A	2 phases, 1 neutral conductor	H05V2V2-F	4x1,5 mm <sup>2</sup>
2x10A	2 phases, 1 neutral conductor	H05V2V2-F	4x1,5 mm <sup>2</sup>

2x06A	2 phases, 1 neutral conductor	H05V2V2-F	4x1,5 mm <sup>2</sup>
2x16A	2 phases, 2 neutral conductors (only for NL)	H05V2V2-F	5x1,5 mm <sup>2</sup>
2x32A	2 phases, 1 neutral conductors	H05V2V2-F	4x4,0 mm <sup>2</sup>
1x48A	1 phase, 1 neutral conductor	H05V2V2-F	3x6,0 mm <sup>2</sup>
1x35A	1 phase, 1 neutral conductor	H05V2V2-F	3x6,0 mm <sup>2</sup>
1x32A	1 phase, 1 neutral conductor	H05V2V2-F	3x4,0 mm <sup>2</sup>
1x25A	1 phase, 1 neutral conductor	H05V2V2-F	3x4,0 mm <sup>2</sup>
1x20A	1 phase, 1 neutral conductor	H05V2V2-F	3x4,0 mm <sup>2</sup>
1x16A	1 phase, 1 neutral conductor	H05V2V2-F	3x4,0 mm <sup>2</sup>

The following connections are possible.

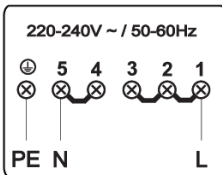

1 phase, 1 neutral conductor (220–240 V~, 50-60 Hz).

To reach the rated maximum power a fuse of 48A is needed. Install a jumper between terminals 1 and 2, between terminals 2 and 3 and between terminals 4 and 5.

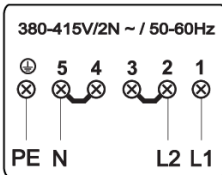

2 phases, 1 neutral conductor (380–415 V 2N~, 50-60 Hz).

To reach the rated maximum power two fuses of 32A are needed. Install a jumper between terminals 2 and 3 and between terminals 4 and 5.

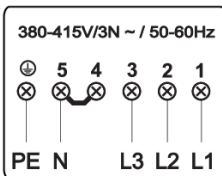

3 phases, 1 neutral conductor (380–415 V 3N~, 50-60 Hz).

To reach the rated maximum power three fuses of 16A are needed. Install a jumper between terminals 4 and 5.

# Electrical installation

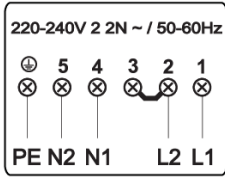

(only for NL)

2 phases, 2 neutral conductors (220–240 V 2-2N~, 50-60 Hz)

To reach the rated maximum power two fuses of 16A are needed. The 2 fuses (L1 and L2) should be secured by only one and the same earth leakage breaker. It is not allowed to run L1/N1 through a different earth leakage breaker than L2/N2.

Install a jumper between terminals 2 and 3!

## Connection only for BE

1. Check the voltage. Before connecting the appliance, make sure the voltage specified on the rating plate conforms to the voltage of your power mains. The voltage of your power mains (220–240 V between L1 and L2) should be checked by an expert using an appropriate measuring device.
2. Open the cover of the connection terminal box.
3. Connect the wires according to your type of appliance.
4. The jumpers are provided separately.
5. Change the power limitation in the Settings when needed. See chapter Settings **Con** for connection setting.

### WARNING!

The appliance may only be connected by an authorised expert. False connection can destroy parts of the appliance. In such case, there is no right to warranty. Disconnect the appliance from the power mains before any repair or maintenance operation.

### Power cord

- Run the power cord through a cord strain relief (clamp) which protects the cable from being pulled out.

## Connection diagram

For appliance types: BI3CA...

### NOTE!

Note: The appliance type can be found on the rating plate on the bottom of the appliance.

Power cord core cross sectional area should be at least 1,5 mm<sup>2</sup> for the following current limiter settings which should be adjusted to your circuit breakers:

Current limiter settings	Connection type	Power cord type	Number and cross section of Power cord wires
1x16A	2 phase conductors	H05V2V2-F	3x1,5 mm <sup>2</sup>
1x13A	2 phase conductors	H05V2V2-F	3x1,5 mm <sup>2</sup>
1x10A	2 phase conductors	H05V2V2-F	3x1,5 mm <sup>2</sup>
1x06A	2 phase conductors	H05V2V2-F	3x1,5 mm <sup>2</sup>



Voltage between line conductors must be 220–240 V~.



2 phase conductors (220–240 V~, 50-60 Hz)

**L1** = black/brown

**L2** = blue

 = yellow-green

For appliance types: BI1CA..., BI6CA..., BI6CB..., BI7CA..., BI8CA..., BI8CB..., BI9CE...

## NOTE!

Note: The appliance type can be found on the rating plate on the bottom of the appliance.

Voltage between lines must be 220–240 V~. Power cord core cross sectional area should be at least as listed in Table for the following current limiter settings which should be adjusted to your circuit breakers:

Current limiter settings	Connection type	Power cord type	Number and cross section of Power cord wires
2x16A	3 phase conductors	H05VV-F	4x1,5 mm <sup>2</sup>
2x13A	3 phase conductors	H05VV-F	4x1,5 mm <sup>2</sup>
2x10A	3 phase conductors	H05VV-F	4x1,5 mm <sup>2</sup>
2x06A	3 phase conductors	H05VV-F	4x1,5 mm <sup>2</sup>
1x32A	2 phase conductors	H05VV-F	3x4,0 mm <sup>2</sup>
1x25A	2 phase conductors	H05VV-F	3x4,0 mm <sup>2</sup>
1x20A	2 phase conductors	H05VV-F	3x4,0 mm <sup>2</sup>
1x16A	2 phase conductors	H05VV-F	3x4,0 mm <sup>2</sup>
1x13A	2 phase conductors	H05VV-F	3x4,0 mm <sup>2</sup>
1x10A	2 phase conductors	H05VV-F	3x4,0 mm <sup>2</sup>
1x06A	2 phase conductors	H05VV-F	3x4,0 mm <sup>2</sup>

The following connections are possible.

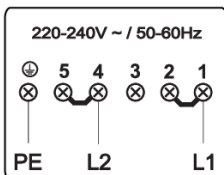

2 phases (220–240 V~, 50-60 Hz)

To reach the rated maximum power a fuses of 32A is needed.

Install a jumper between terminals 1 and 2 and between terminals 4 and 5.

# Electrical installation

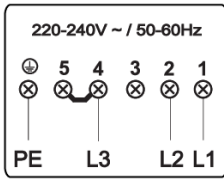

3 phases (220–240 V~, 50-60 Hz)

To reach the rated maximum power a fuses of 32A is needed.

Install a jumper between terminals 4 and 5.

For appliance types: BI9CA..., BI9CB..., BI9CC...

## NOTE!

Note: The appliance type can be found on the rating plate on the bottom of the appliance.

Voltage between lines must be 220–240 V~. Power cord core cross sectional area should be at least as listed in Table for the following current limiter settings which should be adjusted to your circuit breakers:

Current limiter settings	Connection type	Power cord type	Number and cross section of Power cord wires
3x16A	3 phase conductors	H05V2V2-F	4x4,0 mm <sup>2</sup>
3x13A	3 phase conductors	H05V2V2-F	4x4,0 mm <sup>2</sup>
3x10A	3 phase conductors	H05V2V2-F	4x4,0 mm <sup>2</sup>
3x06A	3 phase conductors	H05V2V2-F	4x4,0 mm <sup>2</sup>
2x16A	3 phase conductors	H05V2V2-F	3x1,5 mm <sup>2</sup>
2x13A	3 phase conductors	H05V2V2-F	3x1,5 mm <sup>2</sup>
2x10A	3 phase conductors	H05V2V2-F	3x1,5 mm <sup>2</sup>
2x06A	3 phase conductors	H05V2V2-F	3x1,5 mm <sup>2</sup>
1x48A	2 phase conductors	H05V2V2-F	3x6,0 mm <sup>2</sup>
1x35A	2 phase conductors	H05V2V2-F	3x6,0 mm <sup>2</sup>
1x32A	2 phase conductors	H05V2V2-F	3x4,0 mm <sup>2</sup>
1x25A	2 phase conductors	H05V2V2-F	3x4,0 mm <sup>2</sup>
1x20A	2 phase conductors	H05V2V2-F	3x4,0 mm <sup>2</sup>
1x16A	2 phase conductors	H05V2V2-F	3x4,0 mm <sup>2</sup>

The following connections are possible.

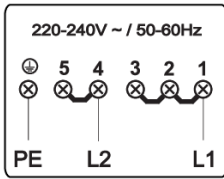

2 phases (220–240 V~, 50-60 Hz).

To reach the rated maximum power a fuse of 48A is needed.

Install a jumper between terminals 1 and 2 and between terminals 4 and 5.

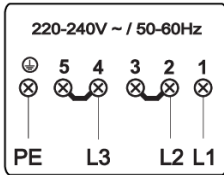

3 phases (220–240 V~, 50-60 Hz).

To reach the rated maximum power a fuses of 48A is needed.

Install a jumper between terminals 2 and 3 and between terminals 4 and 5.

## Current limiter

See chapter Settings, under parameter **Con** - Current limiter to set the parameter. This parameter must be set before any pan is placed on the hob or cooking zone activated

### WARNING!

Current limiter setting must be set according to your connection and circuit breakers by a registered and qualified installer. Please read the Safety regulations and the Installation instruction carefully.

### WARNING!

Setting a lower value of the Current limiter parameter may cause a reduced performance of the induction hob.

# Environmental aspects

## Disposal of packaging and appliance

In the manufacturing of this appliance durable materials were used. Make sure to dispose of this equipment responsibly at the end of its lifecycle. Ask the authorities for more information regarding this.

The appliance packaging is recyclable. The following may have been used:

- cardboard;
- polythene film (PE);
- CFC-free polystyrene (PS hard foam).



Dispose of these materials in a responsible manner and in accordance with government regulations.

As a reminder of the need to dispose of household appliances separately, the product is marked with the symbol of a crossed-out wheeled dustbin. This means that at the end of its working life, the product must not be disposed of as urban waste. It must be taken to a special local authority differentiated waste collection centre or to a dealer providing this service.

Disposing of a household appliance separately avoids possible negative consequences for the environment and health deriving from inappropriate disposal and enables the constituent materials to be recovered to obtain significant savings in energy and resources.

### **Declaration of conformity**

We declare that our products meet the applicable European Directives, Decisions and Regulations and the requirements listed in the standards referenced.

# Compliance information

Radio equipment type:	Wi-Fi module
Operating frequency range:	2.412GHz - 2.472GHz
Maximum output power:	17.7dBm EIRP
Maximum antenna gain:	2.7dBi
Radio equipment type:	HSCIM - 1 module
Frequency range:	2402.0MHz - 2480.0MHz
Carrier Output:	<10dBm
Emission type:	G1D

Hereby, ASKO declare that the radio equipment mentioned above is in compliance with Directive 2014/53/EU. The full text of the EU declaration of conformity is available at the following internet address: [www.celsiuscooking.com/DoC](http://www.celsiuscooking.com/DoC).

The appliance identification card is located on the bottom of the appliance.

Stick the appliance identification card here.

 **ASKO**

ASKO APPLIANCES AB • SOCKERBRUKSGATAN 3, SE-531 40 LIDKÖPING, SWEDEN • [WWW.ASKO.COM](http://WWW.ASKO.COM)



830370-a2

